

biscuit 

Mustafa Timur

Co-Seating&Co-Working



biscuit



Designer: Mustafa Timur Category: Co-Seating&Co-Working
Environment: Indoor Country of Production: Turkey

Product Details

Beech solid wood frame structure is supported by 8mm poplar plywood and 4mm MDF panels. HLB foam is used for seating. Silicon fiber sheet is used for covering sofa after foam fixing before fabric upholstery. 2 cm 32 density foam and silicon fiber is used inside the optional seating pads.

Upholstered Panels

Ø20mm metal profile is used for panel construction. Elastic column is used under the foam. It is covered with 15mm foam and silicon fiber. Optional backrest cushions are filled with silicon fiber.

Leg

Ø38mm tube profile is used. Plastic glides are used under the leg.

Materials

Upholstery

Fabric, Leather, Artificial Leather. COM and COL options are also available.



PANEL 5 WITH 1 SIDE BACKRESTS - P5B1

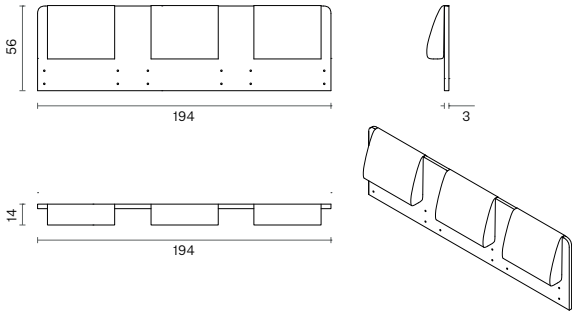

PANEL 5 WITH 2 SIDE BACKRESTS - P5B2

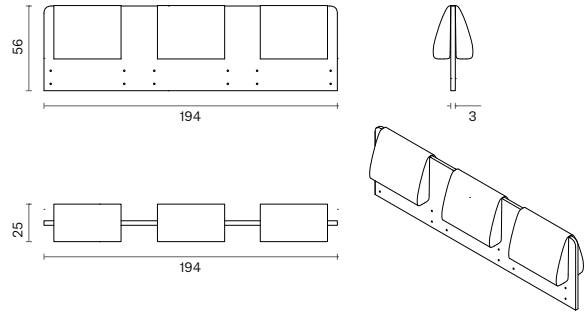

PANEL 6 - P6

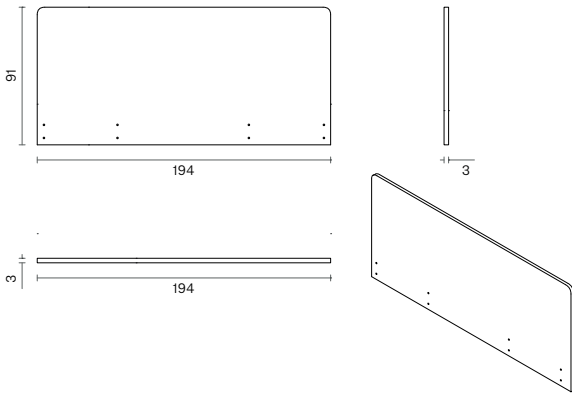

PILLOW 50x50 - PW1

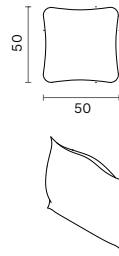

BISCUIT WOODEN MODULES

COOKIE - ST1

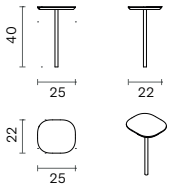

FINGER - ST2

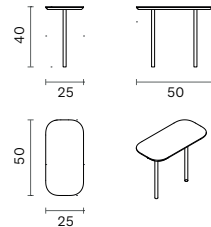

FREE - ST3

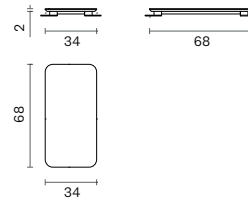

BISCUIT CONFIGURATIONS

Plan 01

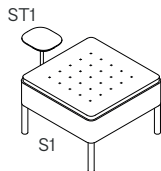
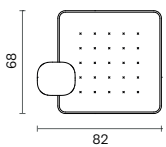

Plan 02

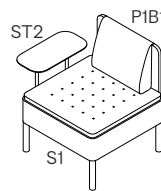
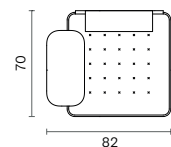

Plan 03

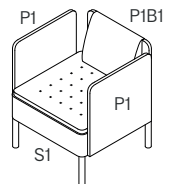
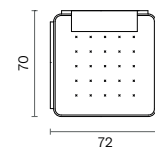

Plan 04

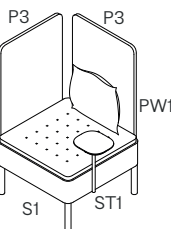
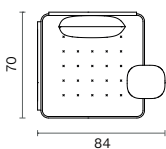

Plan 05

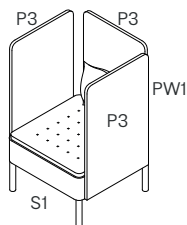
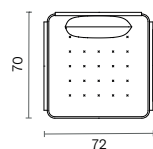

Plan 06

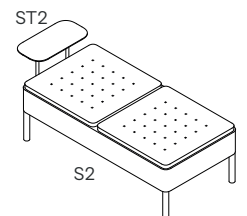
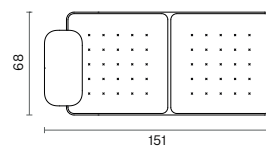

textile fabric yardage (mt)	real leather square meter(m ²)	modules
1,8	3	S1
3,4	5,45	S2
5,1	8,4	S3
0,65	1,1	P1
1,2	1,9	P1B1
1,75	2,8	P1B2
1	1,7	P3
1,25	1,2	P2
2,4	4	P2B1
2,9	5	P2B2
1,1	1,9	P4
1,9	2,3	P5
3,6	5,9	P5B1
4,65	7,8	P5B2
2,1	3,6	P6
0,55	0,85	PW1
		configurations
1,80	3,00	Biscuit 01
3,00	4,90	Biscuit 02
4,30	7,10	Biscuit 03
3,35	5,55	Biscuit 04
5,35	8,95	Biscuit 05
3,40	5,45	Biscuit 06
4,60	7,35	Biscuit 07
7,10	11,65	Biscuit 08
7,00	11,35	Biscuit 09
5,80	9,45	Biscuit 10
7,60	12,45	Biscuit 11
5,70	9,30	Biscuit 12
7,70	12,80	Biscuit 13
10,00	16,50	Biscuit 14
8,15	13,50	Biscuit 15
10,85	17,95	Biscuit 16
15,70	25,65	Biscuit 17
10,20	16,90	Biscuit 18

Side Table (Optional)

22x25 or 50x25 18mm melamine panels are used. 1mm PVC edge band is used.

Melamine Options: See material catalogue for the melamine options.

Metal Leg Finishes

Chrome, Electrostatic Powder Coating Colors, Decorative Coatings

Click to view the fabric and material catalogues via bt.design:

[B&T Fabric Catalogues](#) 

[B&T Material Catalogues](#) 

Dimensions (cm)

TRIPLE POUF - S3

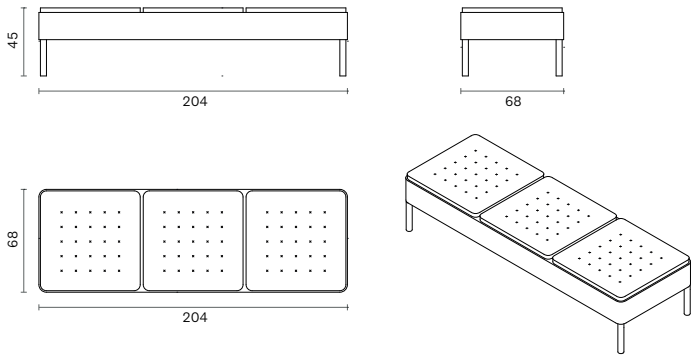

DOUBLE POUF - S2

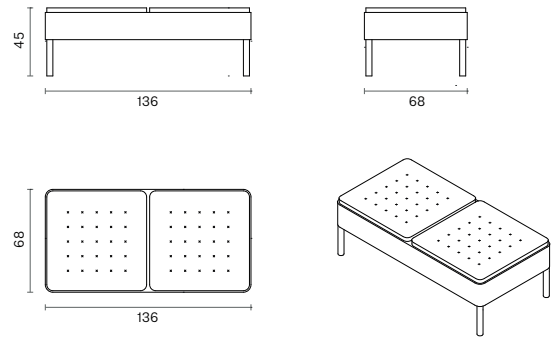

SINGLE POUF - S1

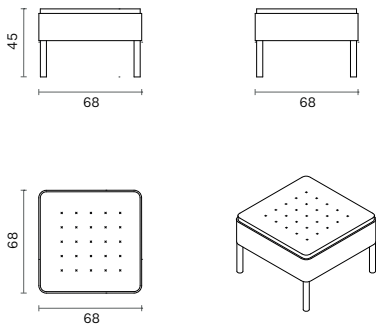

PANEL 1 - P1

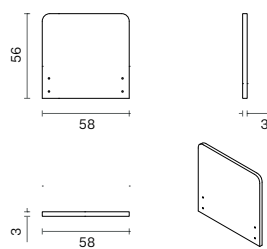

PANEL 1 WITH 1 SIDE BACKRESTS - P1B1

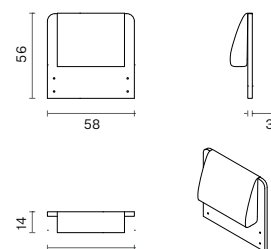

PANEL 1 WITH 2 SIDE BACKRESTS - P1B2

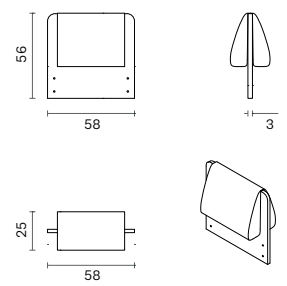

PANEL 2 - P2

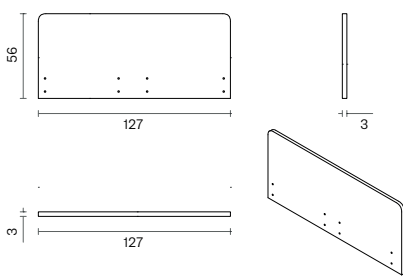

PANEL 2 WITH 1 SIDE BACKRESTS - P2B1

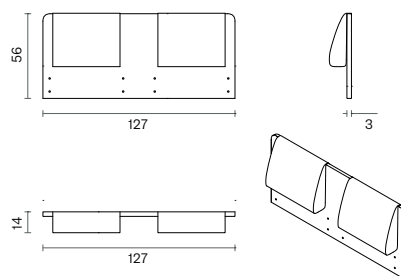

PANEL 2 WITH 2 SIDE BACKRESTS - P2B2

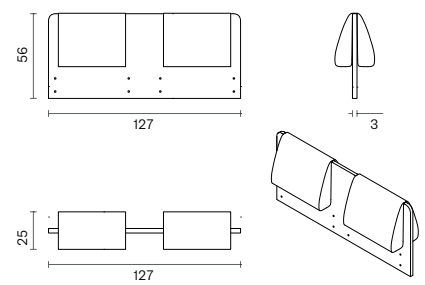

PANEL 3 - P3

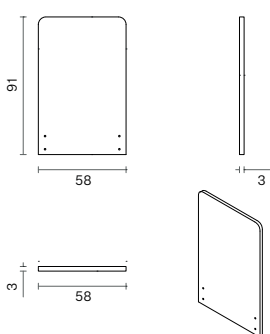

PANEL 4 - P4

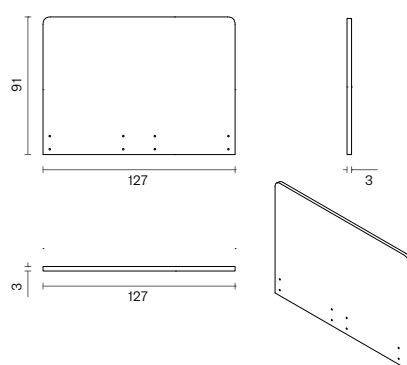

PANEL 5 - P5

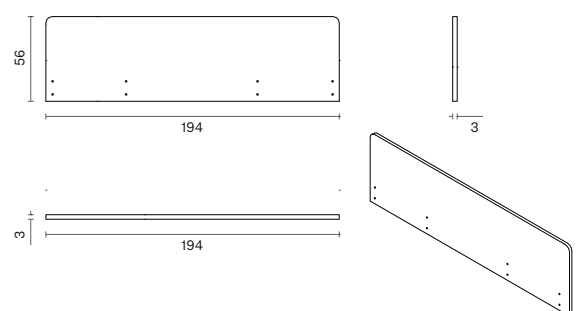

Plan 07

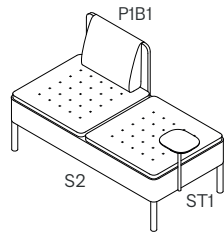
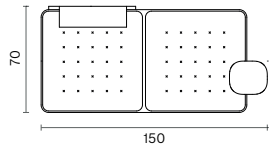

Plan 08

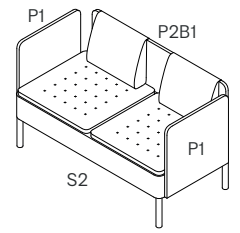
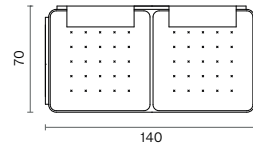

Plan 09

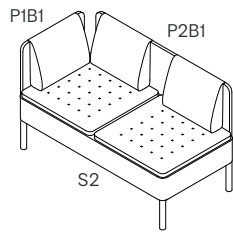
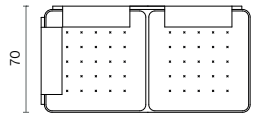

Plan 10

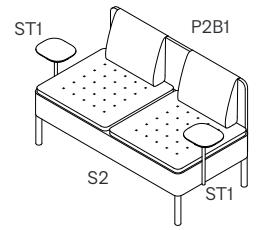
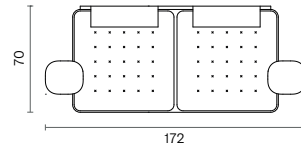

Plan 11

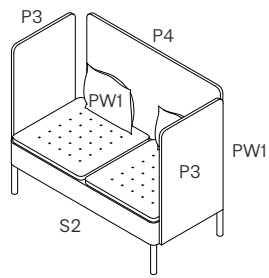
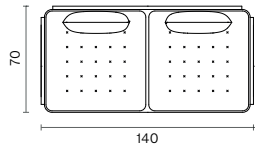

Plan 12

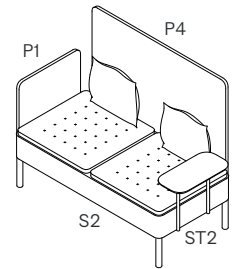
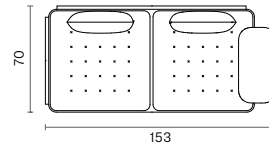

Plan 13

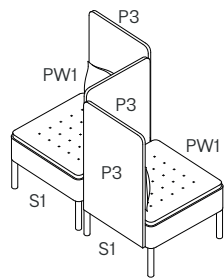
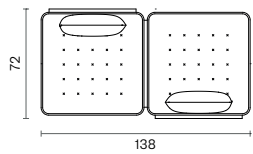

Plan 14

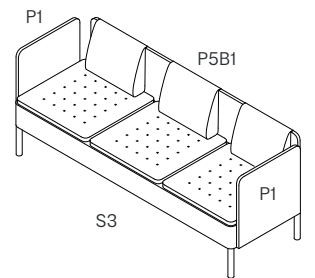
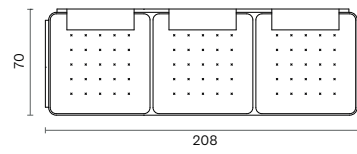

Plan 15

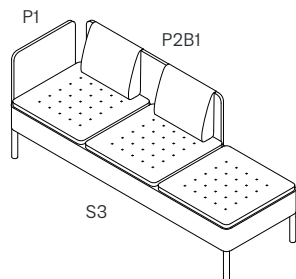
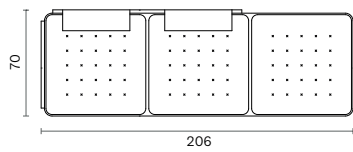

Plan 16

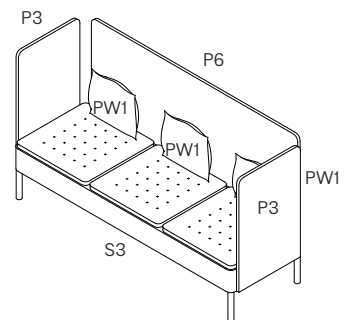
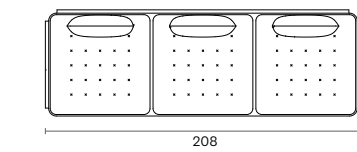

Plan 17

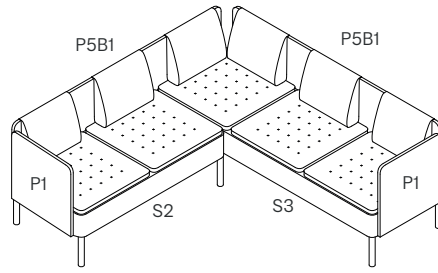
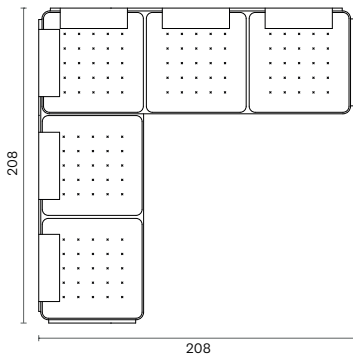

Plan 18

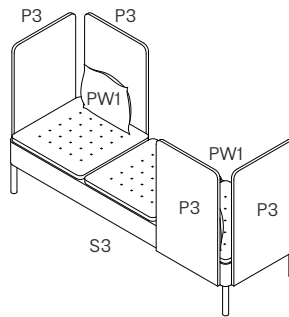
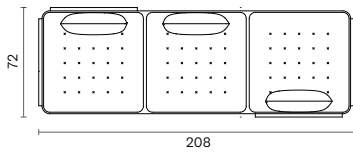

Shipment Details

Cbm (m ³)	Weight (kg)	
0,26	18	S1
0,47	23	S2
0,71	25	S3
0,01	32	P1
0,03	23	P1B1
0,06	23	P1B2
0,016	28	P3
0,023	28	P2
0,78	45	P2B1
0,15	45	P2B2
0,024	23	P4
0,036	23	P5
0,12	23	P5B1
0,24	12	P5B2
0,057	15	P6
0,025	15	PW1
		wooden modules
0,01	46	ST1
0,01	51	ST2
0,015	40	ST3

Downloads ↓

CAD files and photos are available at bt.design

Care and maintenance instructions are available at bt.design

Warranty

The guarantee policy of B&T Design protects their products in case of any defects regarding manufacturing and materials up to 5 years starting from the date of the invoice. Damages caused by lack of proper maintenance or misuse are not included in this warranty.